

Scarlett 18i20

User Guide

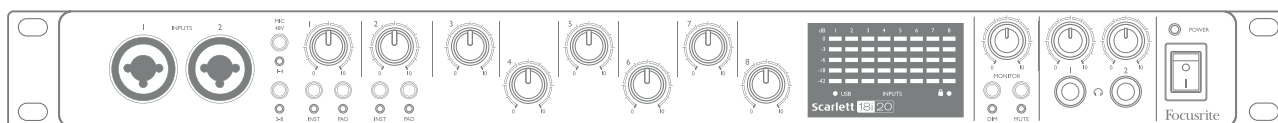

TABLE OF CONTENTS

OVERVIEW	3
Introduction	3
Features	3
Box Contents	4
System requirements	4
Mac OS X	4
Windows	4
GETTING STARTED	5
Software Installation	5
HARDWARE FEATURES	6
Front Panel	6
Rear Panel	8
Connecting your Scarlett 18i20	9
Power	9
USB	9
Mac OS X only	9
Windows only	9
Audio Setup in your DAW	10
Example of Usage	12
Recording a band	12
Low Latency Monitoring	13
Connecting Scarlett 18i20 to loudspeakers	14
Using the ADAT connection	16
Using the Scarlett 18i20 as a stand-alone mixer	17
FOCUSRITE CONTROL	18
SPECIFICATIONS	21
Performance Specifications	21
Physical and Electrical Characteristics	23
TROUBLESHOOTING	24
COPYRIGHT AND LEGAL NOTICES	24

OVERVIEW

Introduction

Thank you for purchasing this Second Generation Scarlett 18i20, one of the family of Focusrite professional audio interfaces incorporating high quality Focusrite analogue pre-amplifiers. In conjunction with the unit's accompanying software application, Focusrite Control, you now have a compact yet highly versatile solution for routing high quality audio to and from your computer. You can also use the Scarlett 18i20 as a "stand-alone" interface to any other type of recording device, once you have configured it using Focusrite Control.

Focusrite Control, and several other exciting and useful software applications, can be downloaded free of charge once you have registered your product. Note that a separate Focusrite Control User Guide is also available; we strongly recommend that you download this as well.

In developing the Second Generation series of Scarlett interfaces, we have enhanced both the performance and feature set including support for sample rates up to 192 kHz, improved mic preamp performance with low noise and plenty of gain, and upgraded instrument inputs with additional headroom for recording the loudest guitar parts without clipping.

Your Second Generation Scarlett interface is compatible with the new Focusrite Control software application: this lets you control various hardware features, set up monitor mixes and configure routings. There is a Focusrite Control installer for both Mac and Windows platforms, and no driver is required for Macs. The Windows version of the installer contains the driver, so in either case, you only need to install Focusrite Control to get up and running.

This User Guide provides a detailed explanation of the hardware to help you achieve a thorough understanding of the product's operational features. We recommend that you take the time to read through the user guide, whether you're new to computer-based recording or a more experienced user, so that you are fully aware of all the possibilities that the Scarlett 18i20 and accompanying software have to offer. If the main User Guide sections do not provide the information you need, be sure to consult <https://support.focusrite.com/>, which contains a comprehensive collection of answers to common technical support queries.

Features

The Scarlett 18i20 audio interface provides the means for connecting microphones, musical instruments, line level audio signals and digital audio signals in both ADAT and S/PDIF formats to a computer running compatible versions of Mac OS or Windows via one of the computer's USB ports. The signals at the physical inputs can be routed to your audio recording software / digital audio workstation (referred to throughout this user guide as the "DAW") at up to 24-bit, 192 kHz resolution; similarly, the DAW's monitor or recorded output signals can be configured to appear at the unit's physical outputs.

The outputs can be connected to amplifiers and speakers, powered monitors, headphones, an audio mixer or any other analogue or digital audio equipment that you wish to use. Although all inputs and outputs on the Scarlett 18i20 are routed directly to and from your DAW for recording and playback, you can configure the routing within your DAW in order to meet your precise needs.

The accompanying software application, Focusrite Control, provides further routing and monitoring options, as well as the ability to control global hardware settings such as sample rate and synchronisation.

All inputs on the Scarlett 18i20 are routed directly to your DAW software for recording, but Focusrite Control also allows you to route these signals internally within the device to the outputs so that you can monitor the audio signals with ultra-low latency - before they arrive at your DAW, should you need to do so.

The Scarlett 18i20 also has connectors for sending and receiving MIDI data, and for transmitting word clock to ensure synchronisation with other items of digital audio equipment.

Box Contents

Along with your Scarlett 18i20 you should find:

- Bundle code* for accessing the following on-line resources:
 - Focusrite Control (also available from www.focusrite.com/downloads)
 - Focusrite Red 2 & 3 Plug-in Suite
 - Softube Time and Tone bundle
 - ProTools | First
 - Ableton Live Lite
 - LoopMasters sample library
 - Novation Bass station
 - Multi-language User Guides for both Scarlett 18i20 and Focusrite Control
- USB cable
- Getting Started Guide and Important Safety Information*

* information printed on the inside of the gift box

System requirements

Mac OS X

Apple Macintosh with a USB 2.0 or 3.0-compliant USB port and an Internet connection*
OS: Mac OS X 10.10 (Yosemite) or OS X 10.11 (El Capitan)**

Windows

Windows compatible computer with a USB 2.0 or 3.0-compliant USB port and an Internet connection*
OS: Windows 7 (32- or 64-bit), 8.1 and 10**

* Internet connection required for downloading on-line resources.

** System requirements are subject to change. Please check the following link for compatibility details:
www.focusrite.com/downloads/os

GETTING STARTED

IMPORTANT: PLEASE ENSURE THAT YOU INSTALL FOCUSRITE CONTROL BEFORE CONNECTING THE INTERFACE TO YOUR COMPUTER.

NOTE THAT THE SECOND GENERATION SCARLETT 18i20 DOES NOT REQUIRE SEPARATE USB DRIVERS TO BE INSTALLED FOR EITHER MAC OR WINDOWS. FOCUSRITE CONTROL INCLUDES THE NECESSARY DRIVERS.

Software Installation

All software required by the Scarlett 18i20 - and several powerful and useful extras - are available for download from the Focusrite website (www.focusrite.com/register). You will find a "Bundle Code" printed on the inside of the box your Scarlett 18i20 comes in, and the Serial number can be found on the underside of the unit. You will need to enter these when you access the downloads area of the website; this procedure ensures that you will have the most up-to-date software versions.

DOWNLOADING THE INCLUDED SOFTWARE

To download the included software, you will need to register your Scarlett 18i20 at www.focusrite.com/register
You will need the product serial number which can be found on the bottom of your 18i20 hardware.
Once you have entered the serial number, you will be asked to enter your BUNDLE CODE, found below:

PRODUCT BUNDLE CODE

For an in depth video tutorial, please go to www.focusrite.com/get-started

Pour obtenir des instructions en Français sur la façon de commencer, veuillez-vous rendre sur focusrite.com/downloads
Für eine Kurzanleitung zum schnellen Start in deutscher Sprache besuche bitte focusrite.com/downloads
Para la guía de inicio en Español, dirijase a focusrite.com/downloads
所有使用说明中文版,请上网站: focusrite.com/downloads
日本語での説明書はこちら: focusrite.com/downloads
시작 방법에 관한 한국어 가이드는 focusrite.com/downloads 에서 찾으실 수 있습니다

1. Using your usual browser, go to www.focusrite.com/register/.
2. Follow the on-screen instructions, entering the Serial number and then the Bundle Code (XXXXXX-XXXXXX-XXXXXX) into the form where prompted. Your Bundle Code is printed on the inside of the gift box.
3. You will then be able to access the "My Products" page, where Focusrite Control and the other software products to which your registration entitles you are available for download, complete with activation codes where applicable.
4. Download and install the Focusrite Control version (Mac or Windows) appropriate for your computer. Follow all on-screen instructions.
5. When the installation is complete, restart your computer.
6. After restart, connect the Scarlett 18i20 to your computer with the USB cable supplied.

This information is accurate as of May 2016, however we are constantly striving to improve the customer experience and as a result this process is subject to change. If anything appears to have changed please refer to www.focusrite.com/get-started for the latest info.

HARDWARE FEATURES

Front Panel

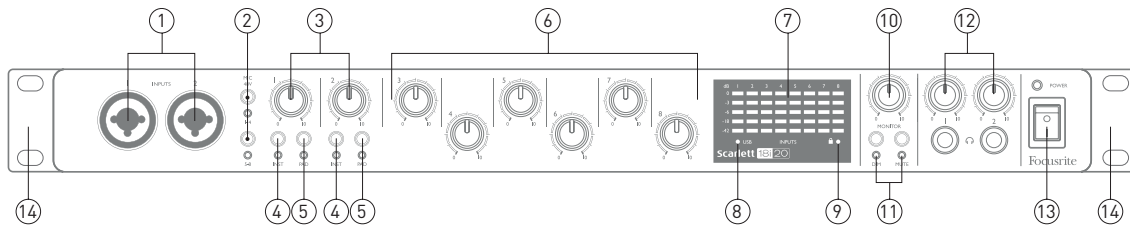



The front panel includes all the input gain and monitoring controls as well as two of the input connectors for Mic, Line and Instrument signals.

1. **Inputs 1 and 2** – Combo type input sockets - connect microphones, instruments (e.g., guitar), or line level signals via XLR or ¼" (6.35 mm) jacks as appropriate. Either ¼" TRS (balanced) or TS (unbalanced) jack plugs can be used for instruments or line level signals.
2. **MIC 48V** – two switches enabling 48 V phantom power at the XLR contacts of the Combo connectors for mic inputs 1-4 and 5-8 respectively. (Note that inputs 3 to 8 are on the rear panel.) The switches each have an associated red LED indicating that phantom power is selected.
3. **Gain 1 & 2** – adjust the input gain for the signals at Inputs 1 and 2 respectively.
4. **INST** – two switches changing the input configuration for the jack contacts at Inputs 1 and 2. When INST is selected, the gain range and input impedance are altered (relative to LINE), and the input is made unbalanced. This optimises it for the direct connection of instruments (usually via a 2-pole (TS) jack plug). When INST is off, the inputs are suitable for the connection of line level signals. Line level signals may be connected either in balanced form via a 3-pole (TRS) jack or unbalanced via a 2-pole (TS) jack. The switches each have an associated red LED indicating that INST is selected.
5. **PAD** – two switches which insert a 10 dB pad in the signal paths of Inputs 1 and 2. With the pad applied, the maximum input signal level is +16 dBu. The switches each have an associated red LED indicating that PAD is selected.
6. **Gain 3 to 8** – adjust the input gain for the signals at Inputs 3 to 8 respectively. (Note that the connectors for these inputs are on the rear panel.)
7. **Input meters** – eight 5-segment LED bargraph meters indicating the signal levels of the eight analogue input signals. The meters show signal level after the input gain stage, and thus their indication is affected by the gain controls. The LEDs illuminate at -42 (green, "signal present"), -18 (green), -6 (green), -3 (yellow) and 0 dBFS (red). A level of 0 dBFS implies digital clipping, and should always be avoided.
8. **USB active LED** – a green LED which illuminates when the unit is recognised by the computer to which it is connected.
9. **Locked** – a green LED which confirms clock synchronisation, either to the Scarlett 18i20's internal clock or to an external digital input.

10. **MONITOR** – main monitor output level control: this will normally control the level at the main monitor outputs on the rear panel, but can be configured in Focusrite Control to adjust the level at any of the unit's ten analogue outputs.
11. **DIM** and **MUTE** – two switches controlling the 18i20's monitor outputs; DIM reduces the output levels by 18 dB, while MUTE turns the outputs off. By default, these switches affect the main monitor outputs 1 and 2, but may be configured in Focusrite Control to act on any of the analogue outputs. The switches each have an associated LED (DIM: yellow, MUTE: red) indicating that the function is selected.
12.  Headphone volume **1** and **2** – connect one or two pairs of stereo headphones at the two ¼" (6.25 mm) TRS jack sockets below the controls. The headphone outputs always carry the signals that are currently routed to analogue outputs 7/8 and 9/10 (as stereo pairs) in Focusrite Control.
13. **POWER** – AC power switch and LED.
14. Rack ears for mounting the Scarlett 18i20 in a standard 19" equipment rack.

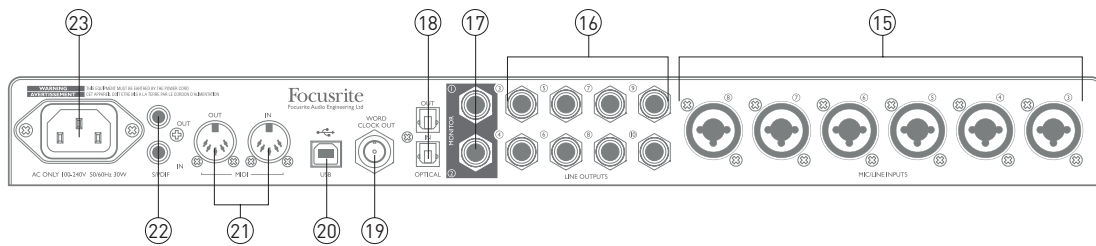
Rear Panel



15. **MIC/LINE INPUTS 3 to 8** – Combo type input sockets - connect further microphones or line level signals via XLR or ¼" (6.35 mm) jacks as appropriate. Either ¼" TRS (balanced) or TS (unbalanced) jack plugs can be used for line level signals.
16. **LINE OUTPUTS 3 and 10** – eight balanced analogue line outputs on ¼" (6.35 mm) jack sockets; use TRS jacks for a balanced connection or TS jacks for unbalanced. The signals available at these outputs are defined in Focusrite Control, and can typically be used for driving alternative speakers (i.e., midfield, nearfield, etc.), the additional speakers in a multichannel monitoring system, or to drive outboard FX processors.
17. **MONITOR 1 and 2** – two balanced analogue line outputs on ¼" (6.35 mm) jack sockets; use TRS jacks for a balanced connection or TS jacks for unbalanced. We recommend the use of balanced connections wherever possible, to minimise grounding and hum problems. These are also Line Outputs 1 and 2 of the system, and will generally be used for driving the main L and R speakers of your monitoring system. However, the signals at the outputs may be defined in Focusrite Control.
18. **OPTICAL IN and OUT** – two TOSLINK connectors, each carrying eight channels of digital audio in ADAT format at 44.1/48 kHz sample rate or four channels at 88.2/96 kHz. These are simply additional inputs 11 to 18 and outputs 13 to 20 (at 44.1/48 kHz) to/from the Scarlett 18i20. Note that the optical input and output are disabled when sample rates of 176.4/192 kHz are in use.
19. **WORD CLOCK OUT** – a BNC connector carrying the Scarlett 18i20's word clock; this may be used to synchronise other digital audio equipment forming part of the recording system. The source of sample clock synchronisation used by the Scarlett 18i20 is selected from Focusrite Control.
20.  **USB 2.0 port** – Type B connector; connect the Scarlett 18i20 to your computer with the cable supplied.
21. **MIDI IN and MIDI OUT** – standard 5-pin DIN sockets for connection of external MIDI equipment. The Scarlett 18i20 acts as a "Break-out (and Break-in) Box", allowing MIDI data to/from your computer to be distributed to additional MIDI devices.
22. **SPDIF IN and OUT** – two phono (RCA) sockets carrying two-channel digital audio signals into or out of the Scarlett 18i20 in S/PDIF format. These appear as Inputs 9 & 10 and Outputs 11 & 12 in Focusrite Control (but note the S/PDIF outputs are unavailable at 176.4/192 kHz sample rates).
23. **AC mains** – standard IEC receptacle.

Connecting your Scarlett 18i20

IMPORTANT: Before you connect your Scarlett 18i20 to your computer, please complete the software installation according to the instructions at page 5. This will ensure that the hardware uses the correct drivers, and will prevent unexpected behaviour.

Power

The Scarlett 18i20 should be connected to AC mains with the supplied AC power cable. Plug the IEC connector into the rear panel IEC receptacle. We recommend that the unit is not turned on until the USB connection has been made (see below).

USB

The Scarlett 18i20 has a single USB 2.0 port (on the rear panel). Once the software installation is complete, simply connect the Scarlett 18i20 to your computer; we recommend you use the USB cable provided. (Note that Scarlett 18i20 is a USB 2.0 device, and thus the USB connection requires a USB 2.0-compliant port on your computer. It will not operate correctly with USB 1.0/1.1 ports, however typically a USB 3.0 port will support a USB 2.0 device.)

When the USB cable has been connected, turn the Scarlett 18i20 on with the front panel power switch.

Mac OS X only:

Your OS should automatically switch the computer's default audio inputs & outputs to the Scarlett 18i20. To verify this, go to **System Preferences > Sound**, and ensure that the input and output are set to **Scarlett 18i20**. For more detailed setup options on a Mac, open **Applications > Utilities > Audio MIDI Setup**.

Windows only:

Your OS should automatically switch the computer's default audio inputs and outputs to be the Scarlett 18i20. To verify this go to: **Start > Control Panel > Hardware and Sound > Sound > Manage Audio Devices** and ensure that **'Default Playback'** and **'Recording'** are set to **'Scarlett 18i20'**

Audio Setup in your DAW

The Scarlett 18i20 is compatible with any Windows-based DAW that supports ASIO or WDM or any Mac-based DAW that uses Core Audio. After installing Focusrite Control and connecting the hardware, you can start using your Scarlett 18i20 with the DAW of your choice. To allow you to get started if you do not already have a DAW application installed on your computer, both Pro Tools | First and Ableton Live Lite are included; these will be available to you once you've downloaded and activated your software online. To install either DAW, download and save the relevant installer file from your registered Focusrite "My Products" page as described on page 5, and then run it, following all on-screen instructions.

Operating instructions for Ableton Live Lite and Pro Tools | First are beyond the scope of this User Guide, but both applications include a full set of Help files. You can also find a video tutorial on getting started with Ableton Live Lite at www.focusrite.com/getting-started.

Please note - your DAW may not automatically select the Scarlett 18i20 as its default I/O device. In this case, you must manually select the driver on your DAW's **Audio Setup*** page (select **Scarlett 18i20** for Mac or **Focusrite USB 2.0** driver for Windows). Please refer to your DAW's documentation (or Help files) if you are unsure where to select the ASIO/Core Audio driver. The example below shows the correct configuration in the Ableton Live Lite **Preferences** panel (Mac version shown).

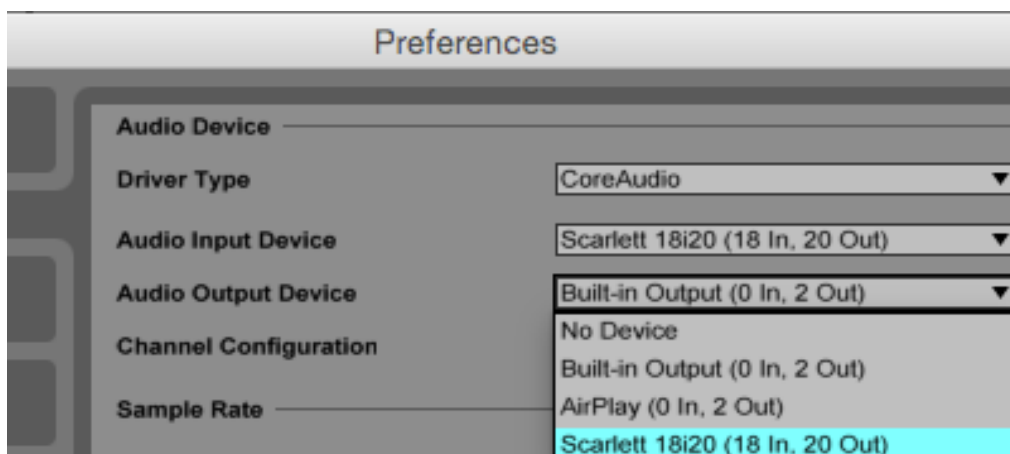
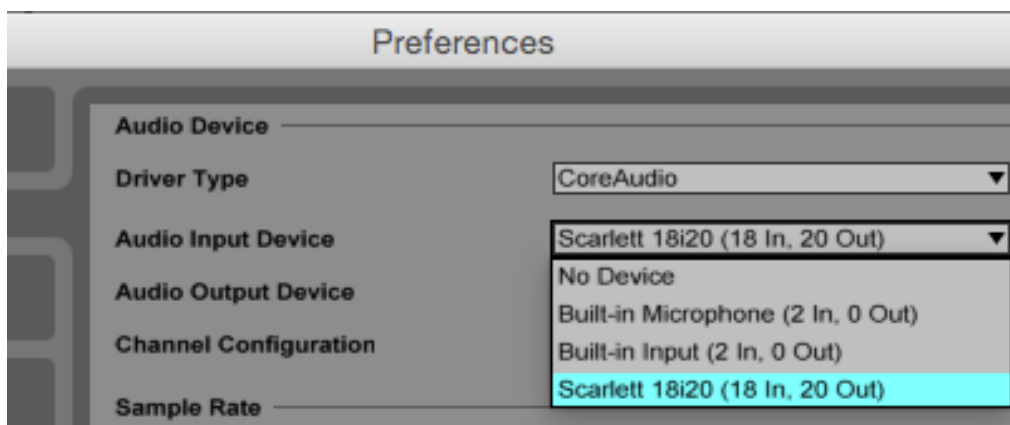

*Typical name. Terminology may differ slightly between DAWs.

Once the Scarlett 18i20 is set as the preferred Audio Device* in your DAW, all 18 inputs and 20 outputs will appear in your DAW's Audio I/O preferences (note however that Ableton Live Lite is limited to a maximum of four simultaneous mono input channels and four simultaneous mono output channels). Depending on your DAW, you may need to enable certain inputs or outputs before use. The two examples below show four inputs and four outputs enabled in Ableton Live Lite Audio Preferences.

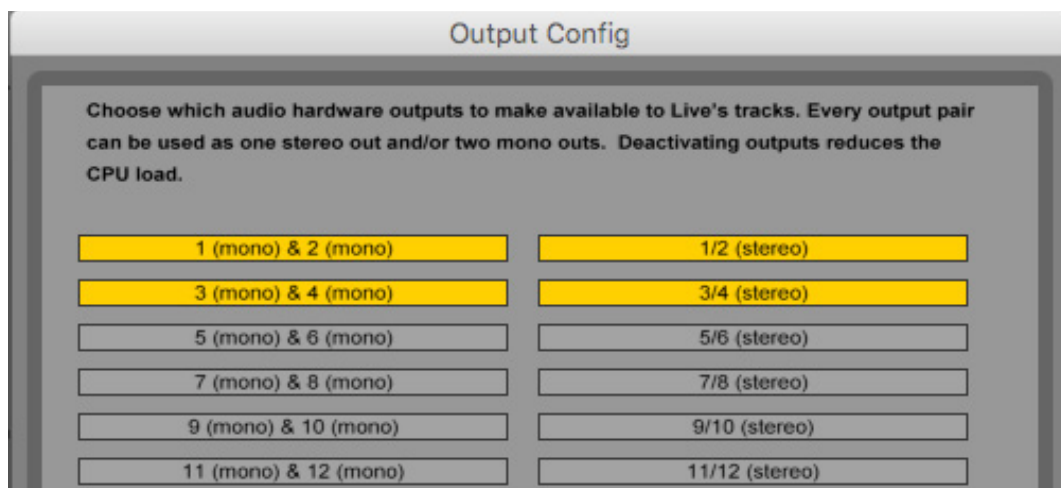
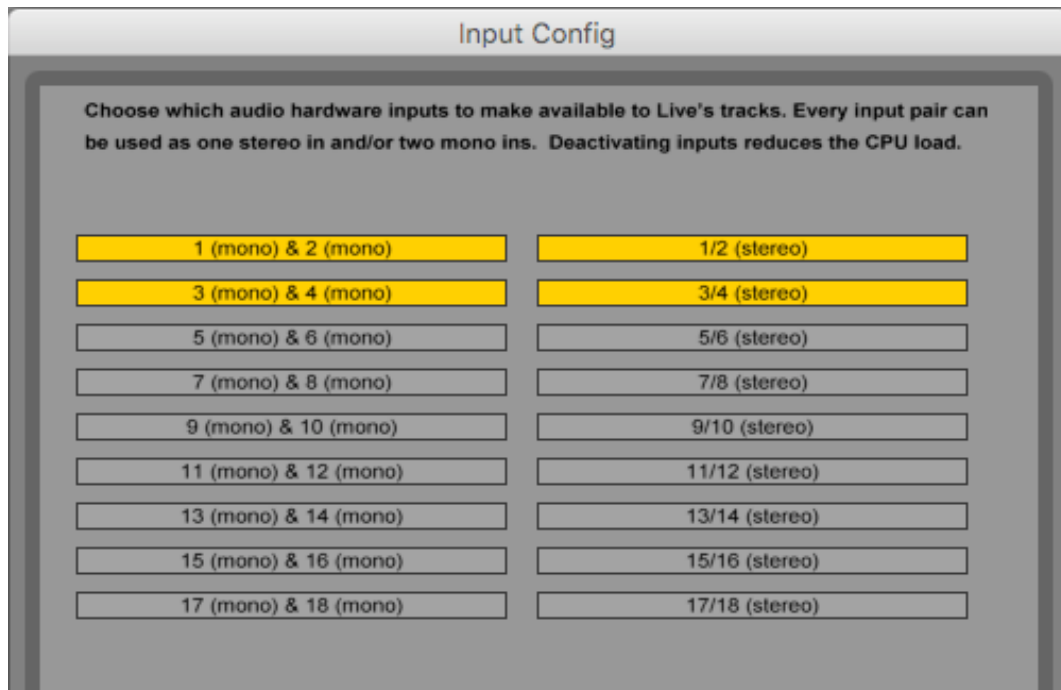

*Typical name. Terminology may differ slightly between DAWs.

Example of Usage

The Scarlett 18i20 is an excellent choice for several different recording and monitoring applications. Some typical configurations are shown below.

Recording a band

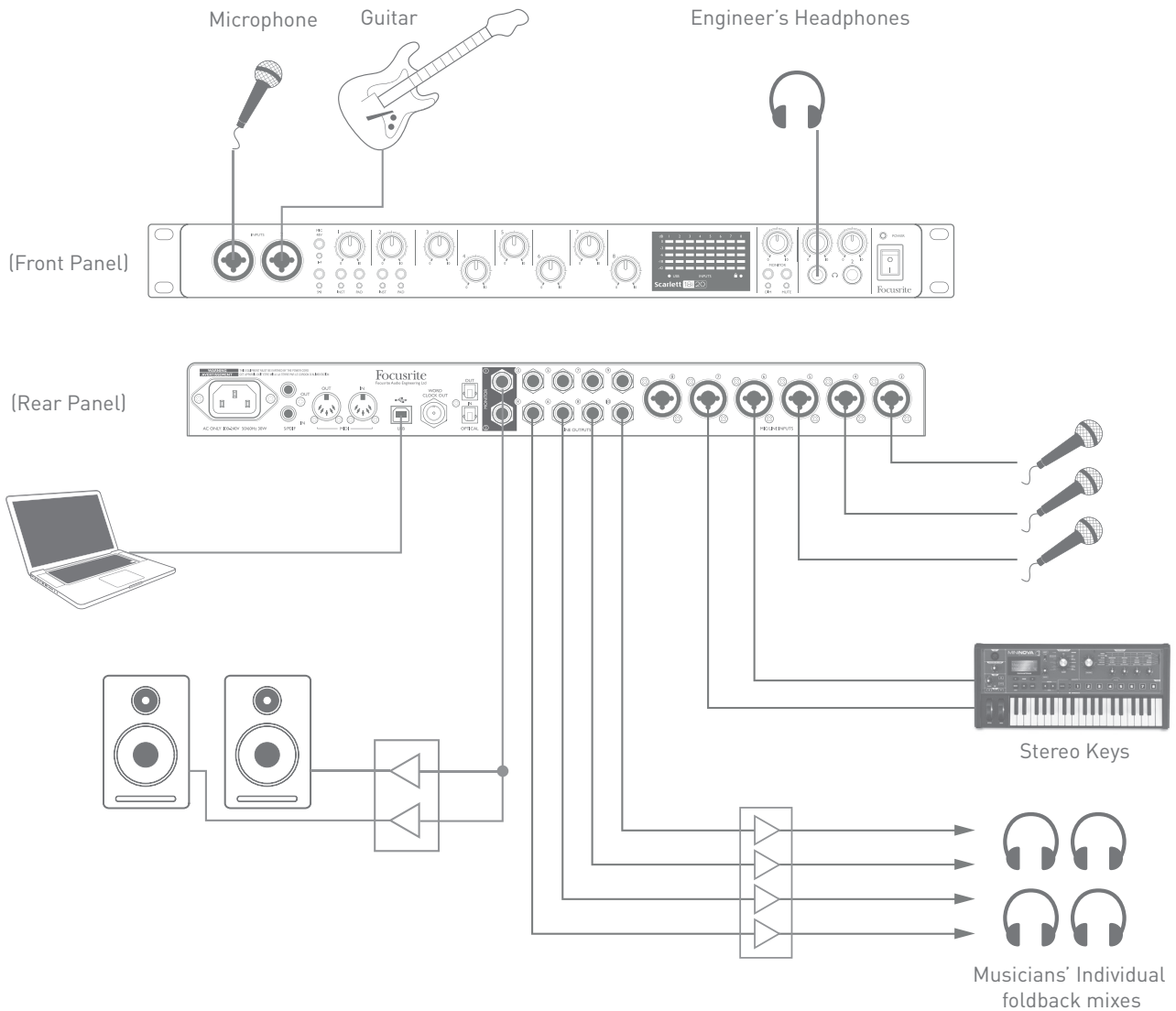

This setup illustrates a typical configuration for recording a group of musicians with DAW software on Mac or PC.

A selection of sources – microphones, a guitar and DI boxes – are shown connected to the Scarlett 18i20's inputs. Note that only Inputs 1 and 2 can be configured to accept instruments directly, so we have chosen to plug the guitar into Input 2. Ensure the **INST** button is pressed and the **INST** LED is illuminated.

The connection to the PC or Mac running DAW software is via the USB cable supplied. This will carry all the input and output signals between the DAW and the Scarlett 18i20. Once the audio setup is correctly configured in the DAW, each input source will be automatically routed to its own DAW track for recording.

Low Latency Monitoring

You will frequently hear the term “latency” used in connection with digital audio systems. In the case of the simple DAW recording application described above, latency will be the time it takes for your input signals to pass through your computer and audio software, and back out again via your audio interface. While not an issue for most simple recording situations, under some circumstances, latency can be a problem for a performer who wishes to record while monitoring their input signals. This might be the case if you need to increase the size of your DAW’s recording buffer, which could be necessary when you record overdubs on a particularly large project using many DAW tracks, software instruments and FX plug-ins.

The Scarlett 18i20, in conjunction with Focusrite Control, allows “low latency monitoring”, which overcomes this problem. You can route your input signals directly to the Scarlett 18i20’s headphone outputs. This enables the musicians to hear themselves with ultra-low latency – i.e., effectively in “real time” – along with the computer playback. The input signals to the computer are not affected in any way by this setting. However, note that any effects being added to the live instruments by software plug-ins will not be heard in the headphones in this case, although the FX will still be present on the recording.

In the example, each of the band members is receiving his/her own monitor mix, because they each have their “own” Scarlett 18i20 output. Focusrite Control lets you define up to eight separate mixes, and these mixes may include previously recorded DAW tracks as well the current input signals.

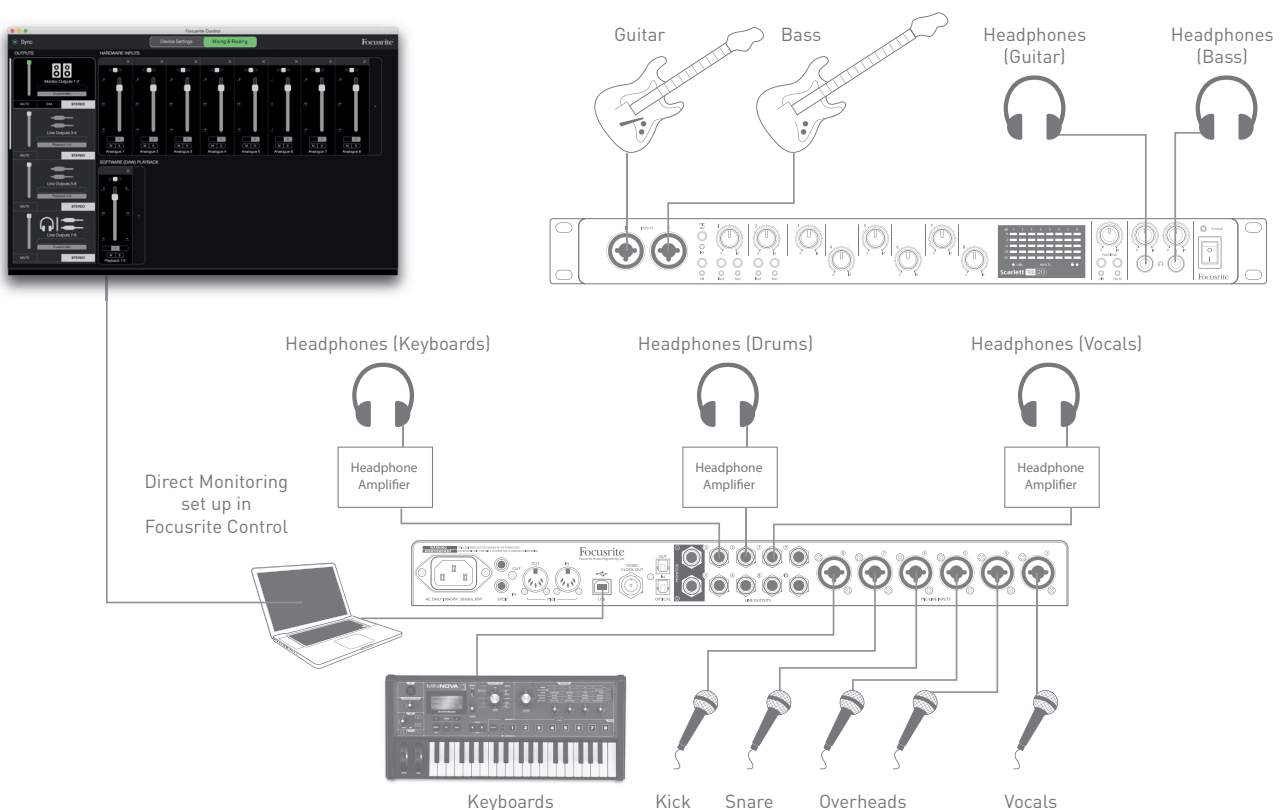

When using Direct Monitoring, ensure that your DAW software is not set to route any inputs (what you are currently recording) to any outputs. If it is, the musicians will hear themselves “twice”, with one signal audibly delayed as an echo.

Connecting Scarlett 18i20 to loudspeakers

The 1/4" jack **MONITOR** outputs on the rear panel (Line Outputs 1 and 2) will normally be used to drive monitoring speakers. Self-powered monitors incorporate internal amplifiers with a volume control, and may be connected directly. Passive loudspeakers will require a separate stereo amplifier; in this case, the rear panel outputs should be connected to the amplifier's inputs.

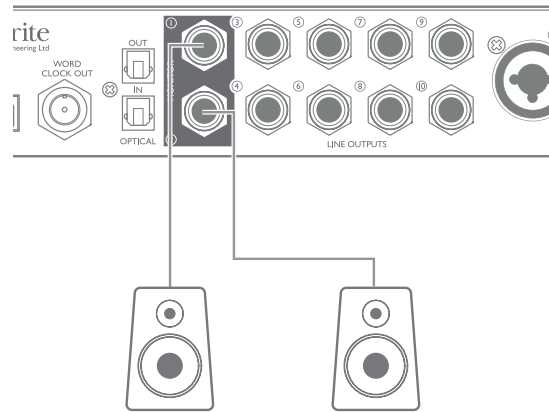

Active Speakers

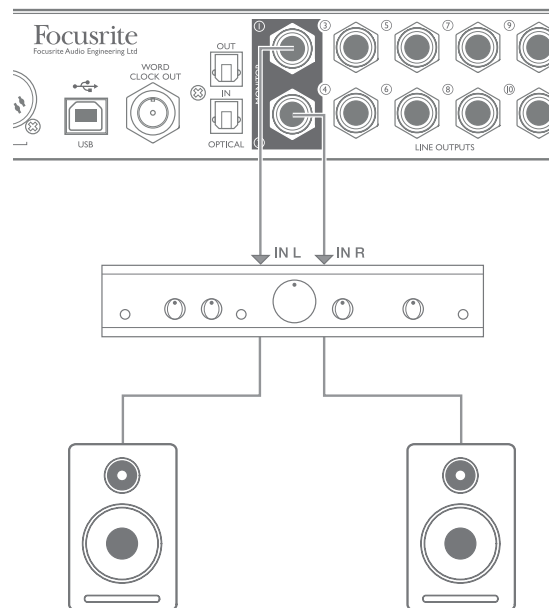

Passive Speakers

All the line output connectors are 3-pole (TRS) 1/4" (6.35 mm) jack sockets, and are electronically balanced. Typical consumer (hi-fi) amplifiers and small powered monitors will probably have unbalanced inputs, either on phono (RCA) sockets, or via a 3.5 mm 3-pole jack plug intended for direct connection to a computer. In either case, use a suitable connecting cable with jack plugs at one end.

Professional active monitors and professional power amplifiers will generally have balanced inputs.

When mixing, you can connect several pairs of additional speakers (mid-field, near-field, etc.) to pairs of outputs and use Focusrite Control to route your mix to the different outputs as desired, to check your mix on the different types of speaker.

NOTE: You run the risk of creating an audio feedback loop if loudspeakers are active at the same time as a microphone! We recommend that you always turn off (or turn down) monitoring loudspeakers while recording, and use headphones when overdubbing.

Working with surround sound

Because the Scarlett 18i20 is equipped with ten line outputs, it is ideally suited for use when working in multichannel sound formats – LCRS, 5.1 surround or 7.1 surround, for example. Using Focusrite Control, simply route each DAW monitor output to the desired speaker.

The example below shows how you would connect the six loudspeakers in a 5.1 surround monitoring arrangement.

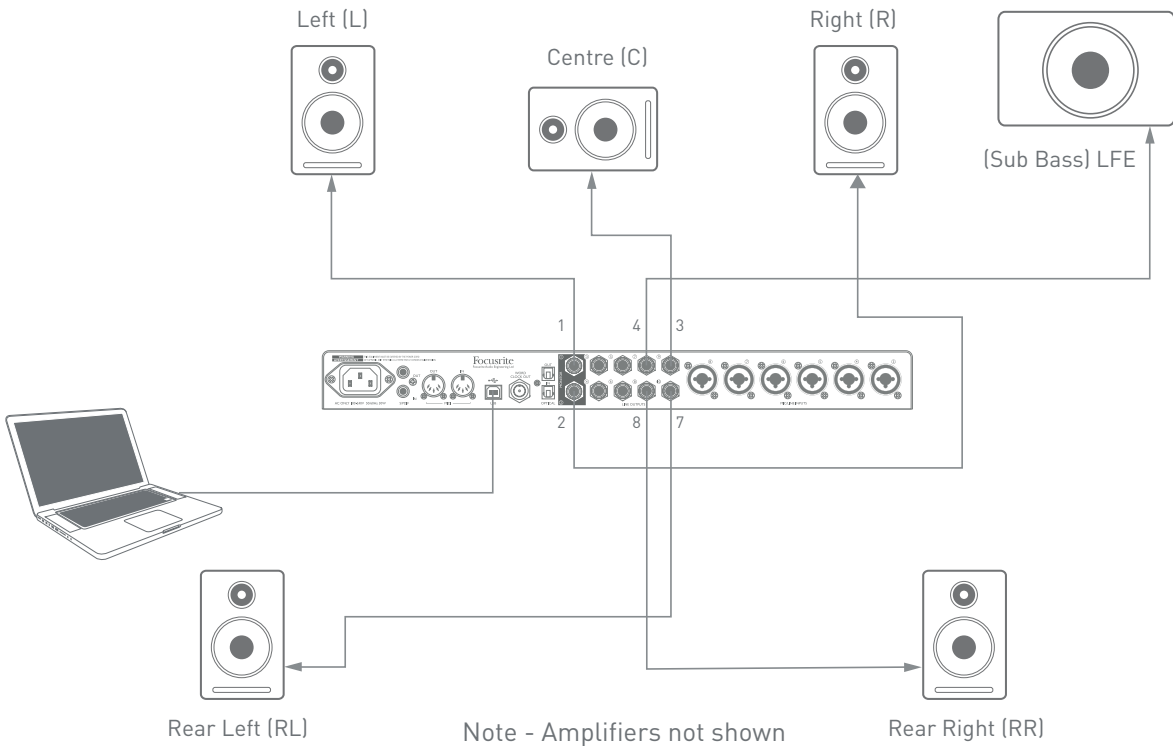

The table below summarises how some common multichannel formats could be mapped to the Scarlett 18i20's outputs for monitoring purposes, as configured within the DAW:

FORMAT	OUT 1	OUT 2	OUT 3	OUT 4	OUT 5	OUT 6	OUT 7	OUT 8
Quad	L	R					RL	RR
2.1	L	R		LFE				
5.1	L	R	C	LFE			RL	RR
7.1	L	R	C	LFE	SL	SR	RL	RR

RL/RR = Rear Left/Rear Right; SL/SR = Side Left/Side Right; LFE = sub-bass channel

Using the ADAT connection

In addition to the eight analogue inputs, the Scarlett 18i20 has an OPTICAL IN ADAT input port which can provide an additional eight audio inputs at 44.1/48 kHz sample rate or four at 88.2/96 kHz. Note that the optical input is disabled when sample rates of 176.4/192 kHz are in use.

Using a separate 8-channel microphone preamplifier equipped with an ADAT output – such as the Focusrite OctoPre MkII – provides a simple and excellent method of expanding the Scarlett 18i20’s input capability.

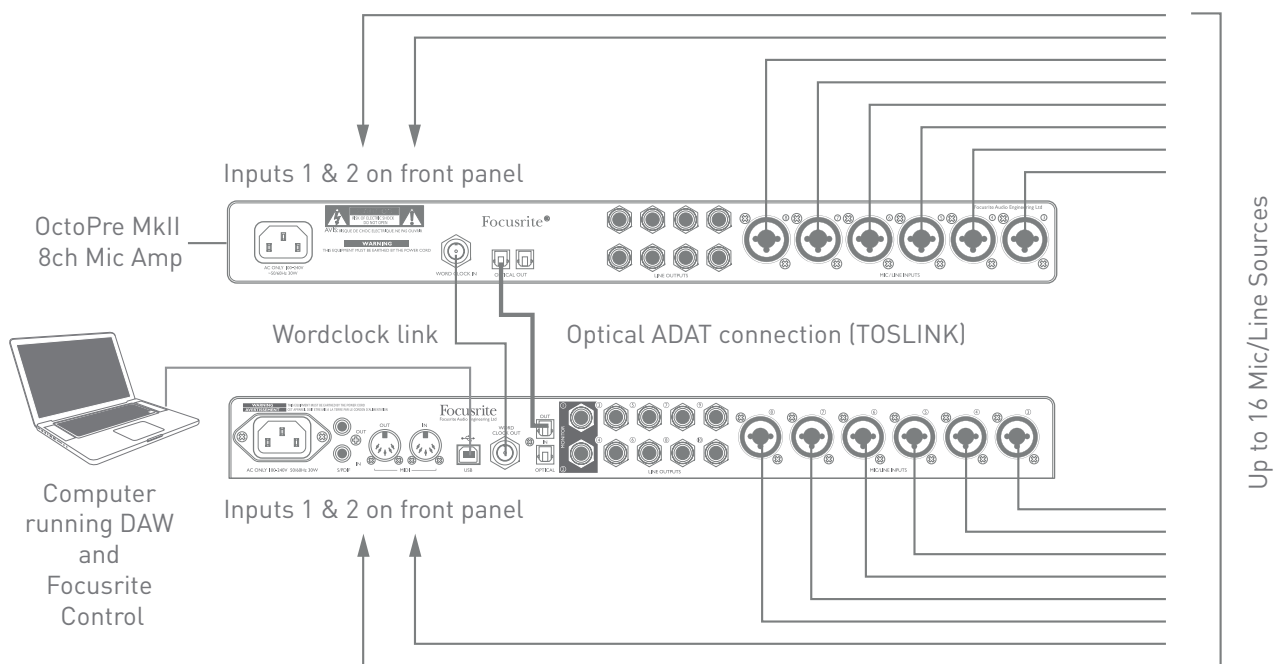

The OctoPre MkII’s ADAT output is connected to the Scarlett 18i20’s **OPTICAL IN** port with a single TOSLINK optical cable. To synchronise the two devices over ADAT, set the clock source of the OctoPre MkII to **Internal** and that of the Scarlett 18i20 (via Focusrite Control) to **ADAT**. Alternatively, stable word clock synchronisation may be achieved by connecting the Scarlett 18i20’s **WORD CLOCK OUT** to the OctoPre MKII’s **WORD CLOCK IN** and setting the OctoPre MkII to use Word Clock as its clock source, Focusrite Control clock source should be set to **Internal**.

TIP: When interconnecting two digital devices by any method, always ensure that both are set to the same sample rate.

The additional inputs realised by use of the ADAT port may be routed using Focusrite Control in exactly the same manner as the other inputs. The additional inputs can form part of any musician’s headphone mix, as required.

If a suitable ADAT “break-out” box is available, the **OPTICAL OUT** ADAT port may be used in the opposite manner; for example, additional outputs from the DAW may be converted into the analogue domain to allow the use of an external hardware mixing console to mix down a large number of DAW tracks.

Using the Scarlett 18i20 as a stand-alone mixer

The Scarlett 18i20 has the ability to store a mix configuration defined in Focusrite Control within the hardware. This feature lets you configure it – for example, as an on-stage keyboard mixer – using your computer, and then upload the configuration to the device itself. Then you can use the Scarlett 18i20 as a simple local mixer as part of your keyboard rig to control the overall mix of multiple keyboards.

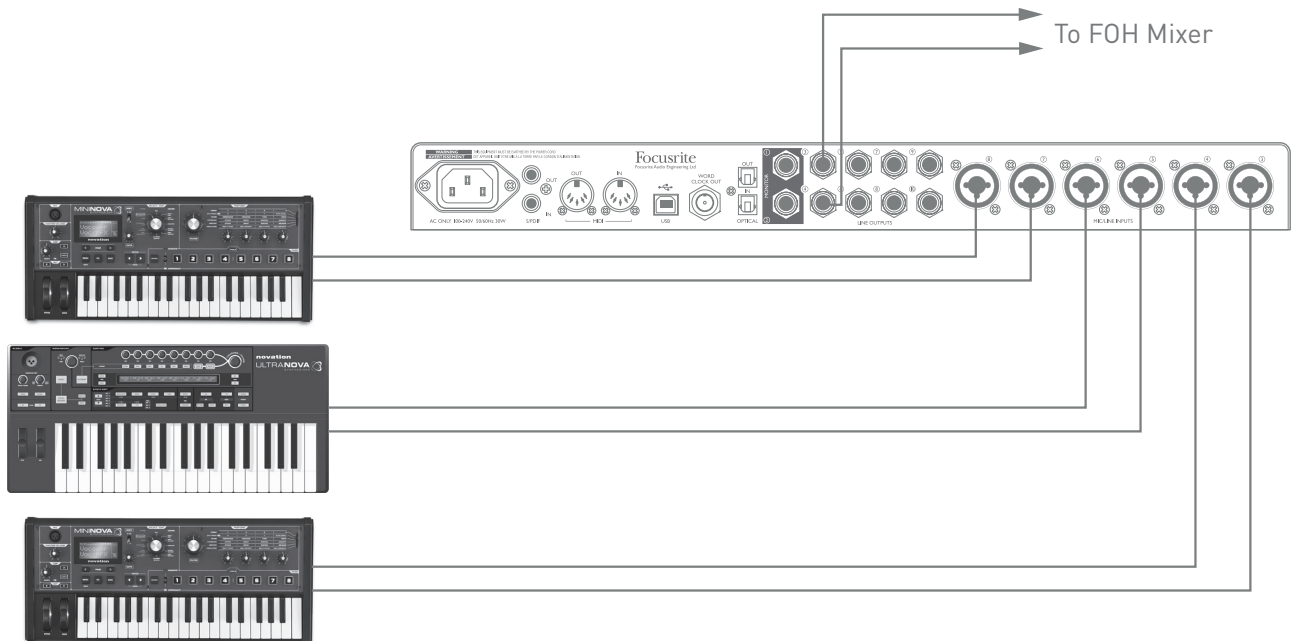

In the example illustrated, three stereo keyboards are connected to the rear panel inputs of the Scarlett 18i20; Outputs 3 and 4 go to the main PA system. The performer can adjust the volume of the individual keyboards from the front panel; he/she can also adjust the overall level of the keyboard mix.

FOCUSRITE CONTROL

Focusrite Control software allows flexible mixing and routing of all audio signals to the physical audio outputs, as well as control of output monitor levels. Sample rate selection and digital sync options are also available from Focusrite Control.

NOTE: Focusrite Control is a generic product, and may be used with other Focusrite hardware interfaces. When you connect an interface to your computer and launch Focusrite Control, the model of interface is automatically detected, and the software configured to suit the number of inputs and outputs, and other facilities, available on the hardware.

IMPORTANT: A separate Focusrite Control User Guide can be downloaded once you have completed the on-line registration process. This describes the use of Focusrite Control in full detail, together with examples of application.

To open Focusrite Control:



Installing Focusrite Control on your computer will place an FC icon on the dock or desktop. Click the icon to launch Focusrite Control.

Assuming that your Scarlett interface is connected to your computer with the USB cable, the Focusrite Control GUI (Graphical User Interface) will appear as shown below (Mac version illustrated).



The following table provides the channel routings when preset option “**Direct Routing**” is selected in Focusrite Control; see the screen image on page 18. Note that as the channel count available via the ADAT optical ports is reduced at higher sample rates, the default routings change slightly at the higher rates.

At 44.1 kHz and 48 kHz sample rates:

CH NO.	INPUTS	OUTPUTS
1	Input 1	Output 1
2	Input 2	Output 2
3	Input 3	Output 3
4	Input 4	Output 4
5	Input 5	Output 5
6	Input 6	Output 6
7	Input 7	Output 7
8	Input 8	Output 8
9	S/PDIF 1	Output 9
10	S/PDIF 1	Output 10
11	ADAT 1	S/PDIF 1
12	ADAT 2	S/PDIF 2
13	ADAT 3	ADAT 1
14	ADAT 4	ADAT 2
15	ADAT 5	ADAT 3
16	ADAT 6	ADAT 4
17	ADAT 7	ADAT 5
18	ADAT 8	ADAT 6
19		ADAT 7
20		ADAT 8

At 88.2 kHz and 96 kHz sample rates:

CH NO.	INPUTS	OUTPUTS
1	Input 1	Output 1
2	Input 2	Output 2
3	Input 3	Output 3
4	Input 4	Output 4
5	Input 5	Output 5
6	Input 6	Output 6
7	Input 7	Output 7
8	Input 8	Output 8
9	S/PDIF 1	Output 9
10	S/PDIF 1	Output 10
11	ADAT 1	S/PDIF 1
12	ADAT 2	S/PDIF 2
13	ADAT 3	ADAT 1
14	ADAT 4	ADAT 2
15		ADAT 3
16		ADAT 4
17		
18		
19		
20		

At 176.4 kHz and 192 kHz sample rates:

CH NO.	INPUTS	OUTPUTS
1	Input 1	Output 1
2	Input 2	Output 2
3	Input 3	Output 3
4	Input 4	Output 4
5	Input 5	Output 5
6	Input 6	Output 6
7	Input 7	Output 7
8	Input 8	Output 8
9	S/PDIF 1	Output 9
10	S/PDIF 1	Output 10
11		
12		
13		
14		
15		
16		
17		
18		
19		
20		

Please refer to the Focusrite Control User Guide for further details.

SPECIFICATIONS

Performance Specifications

Configuration	
Inputs	18: analogue (8), ADAT (8), S/PDIF (2)
Outputs	20: analogue (10), ADAT (8), S/PDIF (2)
Mixer	Fully assignable 18-in/10-out software mixer (Focusrite Control)
Digital Performance	
Supported sample rates	44.1 kHz, 48 kHz, 88.2 kHz, 96 kHz, 176.4 kHz and 192 kHz
Clock jitter	<250 ps
Microphone Inputs	
Frequency Response	20 Hz to 20 kHz, +0.5/-1.5 dB
Dynamic Range	109 dB ('A'-weighted)
THD+N	< 0.002%
Noise EIN	-127 dBu
Maximum Input Level	+8.5 dBu (without pad)
Gain Range	50 dB
Line Inputs 1 & 2	
Frequency Response	20 Hz to 20 kHz, +0.5/-1.5 dB
Dynamic Range	109 dB ('A'-weighted)
THD+N	< 0.003%
Maximum Input Level	+22 dB
Gain Range	50 dB
Line Inputs 3 & 8	
Frequency Response	20 Hz to 20 kHz, +/-0.5 dB
Dynamic Range	110 dB ('A'-weighted)
THD+N	< 0.003%
Maximum Input Level	+16 dB
Gain Range	50 dB

Instrument Inputs	
Frequency Response	20 Hz to 20 kHz, +0.5/-1.5 dB
Dynamic Range	109 dB ('A'-weighted)
THD+N	< 0.003%
Maximum Input Level	+12 dBu
Gain Range	50 dB
Line Outputs 1 to 10	
Frequency Response	20 Hz to 20 kHz, +/-0.5 dB
Dynamic Range	108 dB ('A'-weighted)
THD+N	< 0.001%
Maximum Output Level (0 dBFS)	+16 dBu, balanced
Headphone Outputs	
Frequency Response	20 Hz to 20 kHz, +/-0.5 dB
Dynamic Range	108 dB ('A'-weighted)
THD+N	< 0.001%
Maximum Output Level (0 dBFS)	+13 dBu

Physical and Electrical Characteristics

Analogue Inputs 1 & 2	
Connectors	XLR Combo type: Mic/Line/Inst, on front panel
Mic/Line switching	Automatic
Line/Instrument switching	2 x front panel switches
Phantom power	Shared +48 V phantom power switch for inputs 1 to 4
Analogue Inputs 3 to 8	
Connectors	XLR Combo: Mic/Line, on rear panel
Mic/Line switching	Automatic
Phantom power	Shared +48 V phantom power switch for inputs 1 to 4 and 5 to 8
Analogue Outputs	
Main outputs	10 x balanced ¼" TRS jacks on rear panel
Stereo headphone outputs	2 x ¼" TRS jack on front panel
Main monitor output level control	On front panel
Headphones level controls	
Other I/O	
ADAT I/O	2 x TOSLINK optical connectors; 8 channels @ 44.1/48 kHz or 4 channels @ 88.2/96 kHz
S/PDIF I/O	2 x phono (RCA)
Word clock output	BNC connector
USB	1 x USB 2.0 Type B connector
MIDI I/O	2 x 5-pin DIN sockets
Weight and Dimensions	
W x D x H	482 mm x 45 mm (1U) x 286 mm 19" x 1.73" (1U) x 11.26"
Weight	3.27 kg 7.21 lb

TROUBLESHOOTING

For all troubleshooting queries, please visit the Focusrite Answerbase at <https://support.focusrite.com/hc/en-gb/requests/new> where you will find articles covering numerous troubleshooting examples.

COPYRIGHT AND LEGAL NOTICES

Focusrite is a registered trade mark and Scarlett 18i20 is a trade mark of Focusrite Audio Engineering Limited.

All other trade marks and trade names are the property of their respective owners.
2016 © Focusrite Audio Engineering Limited. All rights reserved.